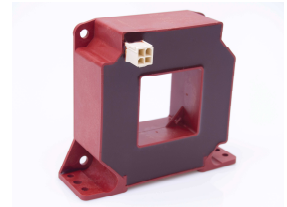

K-No.: 26334

1000 A Current Sensor for ±24V- Supply Voltage
 for electric current measurement:
 DC, AC, pulsed, mixed ..., with a galvanic isolation between
 primary circuit (high power) and secondary circuit (electronic circuit)

Date: 16.01.2017

Customer: Standard Type

Customer part no.:
Page 1 **of** 6

Electrical data

I_{PN}	Primary nominal r.m.s. current	1000	A
R_M^1	Measuring resistance	0 ... 100	Ω
I_{SN}	Secondary nominal r.m.s. current	200	mA
K_N	Turns ratio	(1): 5000	

¹ connected to sensor output, R_M for $I_{P,max}$ see fig. 1 on page 2

Accuracy – Dynamic performance data

		min.	typ.	max.	Einheit
$I_{P,max}^2$	Max. measuring range @ $R_M = 10 \Omega$; $T_A = 25^\circ C$	2500	-	-	A
	@ $R_M = 10 \Omega$; $T_A = 85^\circ C$	2150	-	-	A
X	Accuracy @ I_{PN} , $T_A = -40 \dots +85^\circ C$	-	-	0.4	%
ϵ_L	Linearity	-	-	0.1	%
I_0	Offset current @ $I_P=0$, $T_A = 25^\circ C$	-	-	0.1	mA
I_{OH}	Hysteresis current	-	-	0.1	mA
t_r	Response time @ 80% of I_{PN}	-	< 1	-	μs
t_{ra}	Reaction time @ 10% of I_{PN} ($di/dt = 1200 A/\mu s$)	-	-	1	μs
f_{BW}	Frequency bandwidth	DC...100	-	-	kHz

² currents with high slew rates can be measured above $I_{P,max}$ (transformer behavior)

General data

		min.	typ.	max.	Einheit
ϑ_A	Ambient operating temperature	-40	-	+85	$^\circ C$
ϑ_S	Ambient storage temperature	-40	-	+85	$^\circ C$
m	Mass	-	550	-	g
U_C	Supply voltage	±21.60	±24	±25.2	V
I_{C0}	Current consumption for $I_P = 0A$	-	27	-	mA
I_{CN}	Current consumption for $I_{PN} = 1000A$	-	190	-	mA
* S_{clear}	Clearance	20	-	-	mm
* S_{creep}	Creepage	20	-	-	mm
* U_{sys}	System voltage (determines impulse voltage acc. table 7)	-	-	1000	V_{RMS}
* U_{AC}	Working voltage (acc. U_{ACL} as limit in table 3)	-	-	1000	V_{RMS}
		-	-	1500	V_{DC}
* U_{PD}	Rated discharge voltage (acc. table 24 with $U_{PD}=U_{ACP}$)	-	-	1414	V_{peak}
	Max. potential difference acc. to UL 508	-	-	1000	V_{rms}

* Constructed and manufactured and tested in accordance with EN 61800-5-1:2007 (Pin 1 - 4 to primary opening)
 Reinforced insulation, Insulation material group 1, Pollution degree 2, Overvoltage category III

Datum	Name	Index	Änderung
16.01.17	Ku	84	Typo: Page A4, pin designation changed. Minor change.
25.11.16	Ku	84	Typo: Page 2, Table 55°C/1Ω/2880A changed Dwell time from <10min to <3min. minor change.

Hrsg.: MC-PD editor	Bearb: Ku. designer	MC-PM: KRe. check	freig.: BEF released
------------------------	------------------------	----------------------	-------------------------

Weitergabe sowie Vervielfältigung dieser Unterlage, Verwertung und Mitteilung ihres Inhalts nicht gestattet, soweit nicht ausdrücklich zugestanden. Zuwiderhandlungen verpflichten zu Schadenersatz. Alle Rechte für den Fall der Patenterteilung oder GM-Eintragung vorbehalten

Copying of this document, disclosing it to third parties or using the contents there for any purposes without express written authorization by use illegally forbidden. Any offenders are liable to pay all relevant damages.

K-No.: 26334

1000 A Current Sensor for $\pm 24V$ - Supply Voltage
for electric current measurement:
DC, AC, pulsed, mixed ..., with a galvanic isolation between
primary circuit (high power) and secondary circuit (electronic circuit)

Date: 16.01.2017

Customer: Standard Type

Customer part no.:

Page 2 of 6

**Capability of the sensor for measuring max. peak currents at defined temperatures,
values for supply voltage $\pm 22.80 V (\pm 24 V - 5 \%)$:**

ϑ_A	55 °C	55 °C	55 °C	55 °C	85 °C	85 °C	85 °C	85 °C
R_M	1 Ω	5 Ω	20 Ω	50 Ω	1 Ω	5 Ω	20 Ω	50 Ω
$I_{P,max}$	2880A	2610A	1930A	1270A	2610A	2390A	1810A	1220A
Dwell time	< 3min	< 10min	< 10min	< 30min	< 3min	< 3min	< 3min	< 15min

Limit curve of measurable current $\hat{I}_P=f(R_M)$ Values for supply voltage $\pm 22.80 V (\pm 24 V - 5 \%)$

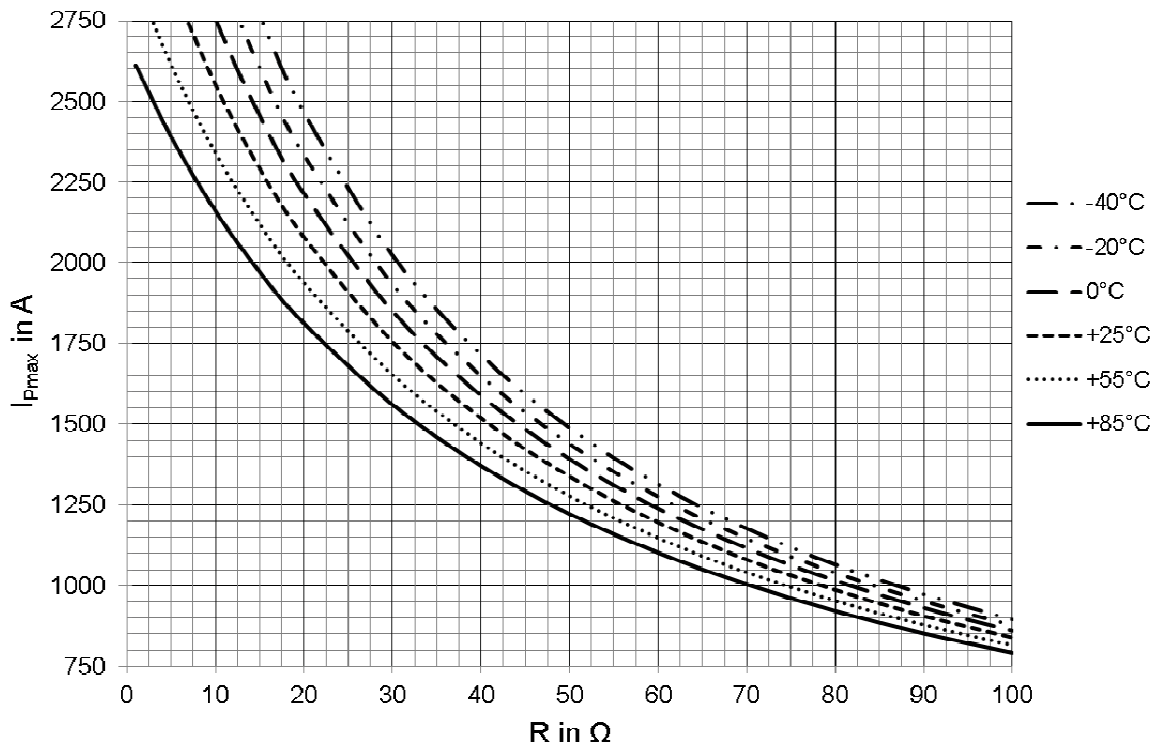

Fig. 1: $I_{P,max} = f(R_M) @ \vartheta_A$

Absolute maximum conditions:

ϑ_A	$\leq 70 \text{ }^\circ\text{C}$	$70 \text{ }^\circ\text{C} < \vartheta_A \leq 85 \text{ }^\circ\text{C}$
$I_P = I_{P,max}$ up to	1800 A _{DC}	1200 A _{DC}

Stresses above these conditions may cause permanent damage. Exposure to absolute maximum rating conditions for extended periods will degrade device reliability and lifetime expectancy. Functional operation of the device at these or any other conditions beyond those specified in this specification is not permitted.

Hrsg.: MC-PD
editor

Bearb: Ku.
designer

MC-PM: KRe.
check

freig.: BEF
released

Weitergabe sowie Vervielfältigung dieser Unterlage, Verwertung und Mitteilung ihres Inhalts nicht gestattet, soweit nicht ausdrücklich zugestanden. Zuwiderhandlungen verpflichten zu Schadenersatz. Alle Rechte für den Fall der Patenterteilung oder GM-Eintragung vorbehalten

Copying of this document, disclosing it to third parties or using the contents there for any purposes without express written authorization by use illegally forbidden. Any offenders are liable to pay all relevant damages.

K-No.: 26334

1000 A Current Sensor for $\pm 24V$ - Supply Voltage
for electric current measurement:
DC, AC, pulsed, mixed ..., with a galvanic isolation between
primary circuit (high power) and secondary circuit (electronic circuit)

Date: 16.01.2017

Customer: Standard Type

Customer part no.:

Page 3 of 6

Overload pulse (μs -range)

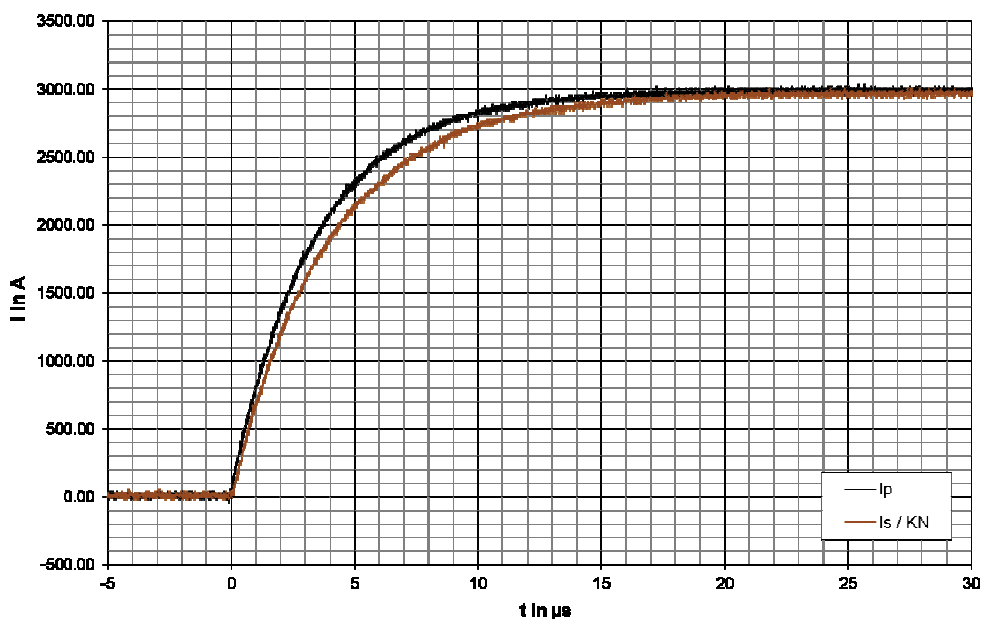
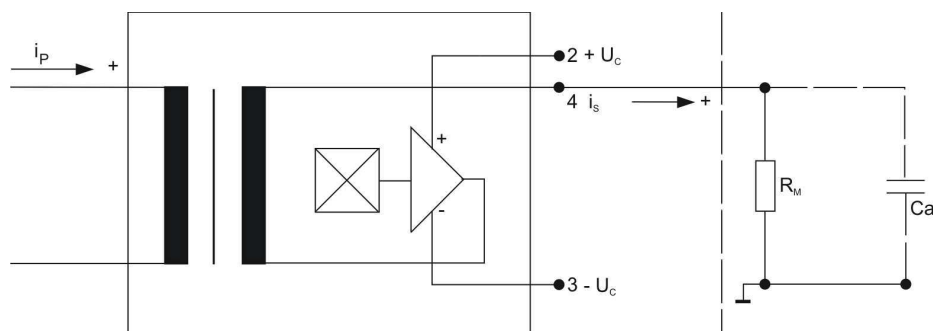

Fig. 2: Output current reaction of a 3kA current pulse with $R_M = 10\Omega$

Schematic diagram:



The polarity of the supply voltage is very important!
With the wrong polarity, the current sensor will be damaged after a few seconds!

Hrsg.: MC-PD
editor

Bearb.: Ku.
designer

MC-PM: KRe.
check

freig.: BEF
released

Weitergabe sowie Vervielfältigung dieser Unterlage, Verwertung und Mitteilung ihres Inhalts nicht gestattet, soweit nicht ausdrücklich zugestanden. Zuwiderhandlungen verpflichten zu Schadenersatz. Alle Rechte für den Fall der Patenterteilung oder GM-Eintragung vorbehalten

Copying of this document, disclosing it to third parties or using the contents there for any purposes without express written authorization by use illegally forbidden. Any offenders are liable to pay all relevant damages.



SPECIFICATION

Item No.:

T60404-P4640-X152

K-No.: 26334

1000 A Current Sensor for $\pm 24V$ - Supply Voltage
for electric current measurement:
DC, AC, pulsed, mixed ..., with a galvanic isolation between
primary circuit (high power) and secondary circuit (electronic circuit)

Date: 16.01.2017

Customer: Standard Type

Customer part no.:

Page 4 of 6

Mechanical outline (mm)

General tolerances DIN ISO 2768-c

Connections:

Connector:
Molex-Minifit Jr.

Pin 1: n.c.
Pin 2: $+U_C$
Pin 3: $-U_C$
Pin 4: I_S (output current)

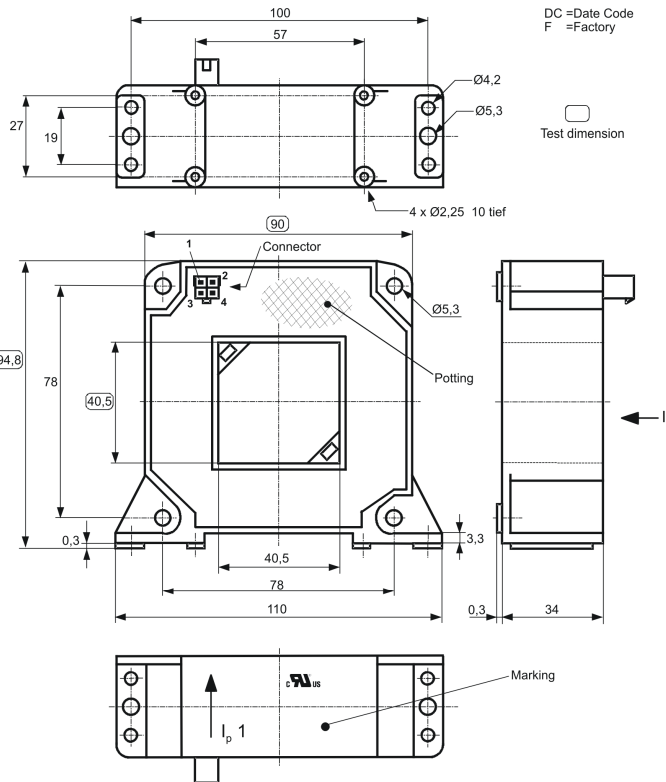

Marking

Explanation: Item number: see Tab.2 (left column)

F = Factory code

DC = Date code

Example: Sensor with end number X152

Produced in Slovakia in April 2015

→ Part number: 4640-X152

→ Factory code: SK

→ Date code: F4

Arrow shows positive current direction

VAC logo

UL logo

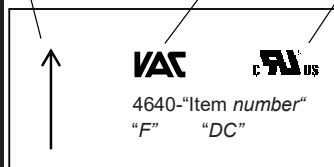

Hrsg.: MC-PD
editor

Bearb: Ku.
designer

MC-PM: KRe.
check

freig.: BEF
released

Weitergabe sowie Vervielfältigung dieser Unterlage, Verwertung und Mitteilung ihres Inhalts nicht gestattet, soweit nicht ausdrücklich zugestanden. Zuwiderhandlungen verpflichten zu Schadenersatz. Alle Rechte für den Fall der Patenterteilung oder GM-Eintragung vorbehalten

Copying of this document, disclosing it to third parties or using the contents there for any purposes without express written authorization by use illegally forbidden. Any offenders are liable to pay all relevant damages.



SPECIFICATION

Item No.: **T60404-P4640-X152**

K-No.: 26334	1000 A Current Sensor for ±24V- Supply Voltage for electric current measurement: DC, AC, pulsed, mixed ..., with a galvanic isolation between primary circuit (high power) and secondary circuit (electronic circuit)	Date: 16.01.2017
Customer: Standard Type	Customer part no.:	Page 5 of 6

Offset ripple reduction

The offset ripple can be reduced by an external low pass. The simplest solution is a passive low pass filter of 1st order by connecting a capacitor parallel to the burden resistor R_M as shown on page 3. The required capacitance can be calculated as follows:

$$C_a = \frac{1}{2\pi \cdot R_M \cdot f_g}$$

In this case the response time is enlarged. It is calculated from:

$$t'_r \geq t_r + 2,5R_M C_a$$

Routine Test¹⁾ (Measurement after temperature balance of the samples at room temperature; SC = significant characteristic)

$K_N(N_1/N_2)$	(100%) M3011/6	Transformation ratio ($I_{PN}=1000A$, 40-80 Hz)	1 : 5000 ± 0.4	% (SC)
I_0	(100%) M3226	Offset current	< 0.1	mA (SC)
U_P	(100%) M3014	Test voltage (1s) Pin 1 - 4 to primary opening	(RMS) 2.2	kV (SC)
U_{PDE}	(AQL 1/S4)	Partial discharge voltage (extinction)	(RMS) 1500	V
$U_{PD(rms)} \cdot 1.875$		*acc. table 24	(RMS) 1875	V

Type Test (Pin 1 - 4 to primary opening)

\dot{U}_W	M3064	HV transient test, *acc. table 18, 19 (1.2 μs / 50 μs-wave form)	12	kV
U_P	M3014	Test voltage (5s)	(RMS) 6	kV
U_{PDE}		Partial discharge voltage (extinction)	(RMS) 1500	V
$U_{PD(rms)} \cdot 1.875$		*acc. table 24	(RMS) 1875	V
ESD	EN 61000-4-2	contact / surface	±8 / ±15	kV

* IEC 61800-5-1:2007.

Applicable documents

Constructed and manufactured and tested in accordance with EN 61800-5-1:2007

Further standards: UL 508 ; file E317483, category NMTR2 / NMTR8

Hrsg.: MC-PD editor	Bearb: Ku. designer		MC-PM: KRe. check		freig.: BEF released
------------------------	------------------------	--	----------------------	--	-------------------------

Weitergabe sowie Vervielfältigung dieser Unterlage, Verwertung und Mitteilung ihres Inhalts nicht gestattet, soweit nicht ausdrücklich zugestanden. Zuwiderhandlungen verpflichten zu Schadenersatz. Alle Rechte für den Fall der Patenterteilung oder GM-Eintragung vorbehalten

Copying of this document, disclosing it to third parties or using the contents there for any purposes without express written authorization by use illegally forbidden.
Any offenders are liable to pay all relevant damages.

K-No.: 26334	1000 A Current Sensor for ±24V- Supply Voltage for electric current measurement: DC, AC, pulsed, mixed ..., with a galvanic isolation between primary circuit (high power) and secondary circuit (electronic circuit)	Date: 16.01.2017
Customer: Standard Type	Customer part no.:	Page 6 of 6

Explanation to parameters used in this datasheet

Accuracy

$X_{total}(I_{PN})$: The sum of all possible errors over the temperature range by measuring a current I_{PN} :

$$X_{total} = 100 \cdot \left| \frac{I_S(I_{PN})}{K_N \cdot I_{PN}} - 1 \right|$$

X : Permissible measurement error in the final inspection at RT. I_{SB} is the DC output current for a DC primary current with the same value as the (positive) rated current I_{PN} (with $I_0 = 0$)

$$X = 100 \cdot \left| \frac{I_{SB}}{I_{SN}} - 1 \right|$$

X_{Ti} : Temperature drift of the rated value orientated output term. I_{SN} (cf. Notes on F_i) in a specified temperature range: I_{SB} is the secondary current at temperature ϑ_{A1} or ϑ_{A2}

$$X_{Ti} = 100 \cdot \left| \frac{I_{SB}(\vartheta_{A2}) - I_{SB}(\vartheta_{A1})}{I_{SN}} \right|$$

ϵ_L : Linearity fault where I_P is any input DC and I_{Sx} the corresponding output term. ($I_0 = 0$).

$$\epsilon_L = 100 \cdot \left| \frac{I_P}{I_{PN}} - \frac{I_{Sx}}{I_{SN}} \right|$$

Offset and drift

I_{OH} : Zero variation after overloading with a DC of tenfold the rated value ($R_M = R_{MN}$)

I_{Ot} : Long term drift of I_0 after 100 temperature cycles in the range -40 to 85 °C.

Dynamic properties

t_{ra} Reaction time, measured as a delay time between a rectangular primary current ($di/dt \approx 1200A/\mu s$) and the output current I_S at $I_P = 0.1 \cdot I_{PN}$

t_r : Response time, measured as a delay time between a rectangular primary current and the output current I_S at $I_P = 0.9 \cdot I_{PN}$

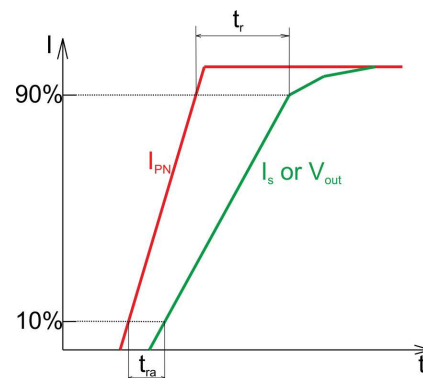

Voltage ratings (according to IEC 61800-5-1:2007)

U_{PD} Rated discharge voltage (recurring peak voltage separated by the insulation)

U_{sys} System voltage: RMS value of rated voltage

U_{AC} Working voltage: RMS voltage which occurs by design in a circuit or across an insulation

Hrsg.: MC-PD editor	Bearb: Ku. designer	MC-PM: KRe. check	freig.: BEF released
------------------------	------------------------	----------------------	-------------------------